



**BP 249
44158 ANCENIS CEDEX - FRANCE
TEL: 33 (0)2 40 09 10 11**

YOUR DEALER

547973 EN (12/10/2007)

**MT 728 Série C-E2
MT 732 Série C-E2
MT 732 Turbo Série C-E2
MT 928 Série C-E2
MT 932 Série C-E2
MT 932 Turbo Série C-E2
MT 1030 S Série 3-E2
MT 1030 S Turbo Série 3-E2**

OPERATOR'S MANUAL

THIS OPERATOR'S MANUAL MUST BE KEPT IN THE LIFT TRUCK AND MUST BE READ AND UNDERSTOOD BY OPERATORS.

DESCRIPTION

- 1 - DRIVER'S SEAT**
- 2 - SAFETY BELT**
- 3 - CONTROL AND SIGNAL LIGHTS PANEL**
- 4 - LONGITUDINAL STABILITY ALARM**
- 5 - SWITCH PANELS**
- 6 - LIGHT SWITCH, HORN AND INDICATOR SWITCH**
- 7 - FRONT AND REAR WINDSCREEN WIPER SWITCH**
- 8 - IGNITION SWITCH**
- 9 - BRAKING OIL TANK AND WINDSCREEN WASHER ACCESS PANEL**
- 10 - BRAKING OIL TANK**
- 11 - WINDSCREEN WASHER TANK**
- 12 - FUSE AND RELAY ACCESS PANEL**
- 13 - FUSE AND RELAY**
- 14 - ACCELERATOR PEDAL**
- 15 - SERVICE BRAKE AND TRANSMISSION CUT-OFF PEDAL**
- 16 - GEAR LEVER AND TRANSMISSION CUT-OFF**
- 17 - REVERSING GEAR**
- 18 - PARKING BRAKE LEVER**
- 19 - STEERING SELECTION**
- 20 - HYDRAULIC CONTROLS AND TRANSMISSION CUT-OFF**
- 21 - LOAD CHARTS FILE**
- 22 - HEATER CONTROL**
- 22 - AIR CONDITIONING CONTROLS (OPTION AIR CONDITIONING)**
- 23 - CAB FILTER VENTILATORS**
- 24 - WINDSCREEN DEMIST VENTS**
- 25 - HEATING VENTS**
- 26 - DOOR LOCK**
- 27 - LOCKING HANDLE FOR UPPER HALF DOOR**
- 28 - RELEASING BUTTON FOR UPPER HALF DOOR**
- 29 - HANDLE FOR REAR WINDOW OPENING**
- 30 - TOOL BOX AND DOCUMENT HOLDER**
- 31 - FRONT LIGHTS (NOT ILLUSTRATED)**
- 32 - REAR LIGHTS (NOT ILLUSTRATED)**
- 33 - FLASHING LIGHT (NOT ILLUSTRATED)**
- 34 - DOCUMENT HOLDER NET**
- 35 - SPIRIT LEVEL**
- 36 - SUN VISOR**
- 37 - ROOF LIGHT**
- 38 - HOOK**

NOTE: All the terms such as: RIGHT, LEFT, FRONT, REAR are meant for an observer seated on driver's seat and looking in front of him.

1 - DRIVER'S SEAT

DESIGNED FOR MAXIMUM COMFORT, THIS SEAT CAN BE ADJUSTED AS FOLLOWS.

LONGITUDINAL ADJUSTMENT

- Pull locking lever 1 towards the right.
- Slide the seat to the required position.
- Release the lever and be sure it returns to the lock position.

SEAT SUSPENSION ADJUSTMENT

- Refer to the seat's graduation.
- Turn handle 2 depending on the driver's weight.

ADJUSTMENT OF THE ANGLE OF THE BACK-REST

- Pull locking lever 3 upwards.
- Slide the back-rest to the required position.
- Release the lever and be sure it returns to the lock position.

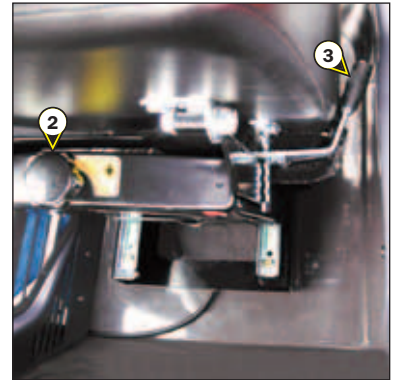
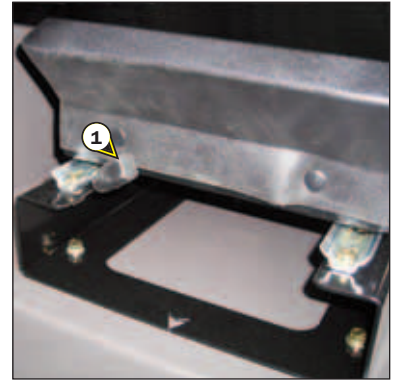

1 - DRIVER'S SEAT (OPTION)

DESIGNED FOR MAXIMUM COMFORT, THIS SEAT CAN BE ADJUSTED AS FOLLOWS.

WEIGHT ADJUSTMENT (FIG. A)

It is advised that the weight be adjusted when the driver is not sitting in the cab.

- Refer to graduation 1 of the seat.
- Turn handle 2 according to the driver's weight.

NOTE: To avoid any health problems, it is recommended that the weight should be checked and adjusted before starting up the lift truck.

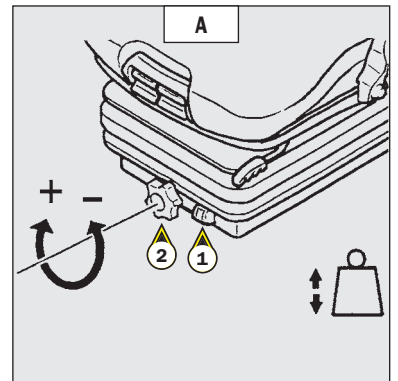

SEAT HEIGHT ADJUSTMENT (FIG. B)

Raise the seat to the desired position, until you hear the ratchet click. If you raise the seat above the last notch (stop), the seat drops down to the lowest position.

SEAT BACK-REST ANGLE ADJUSTMENT (FIG. C)

The back-rest angle of the seat may be adjusted to suit the individual.

- Press the left-hand button while pushing on the seat or relaxing pressure on the seat to find a comfortable position.

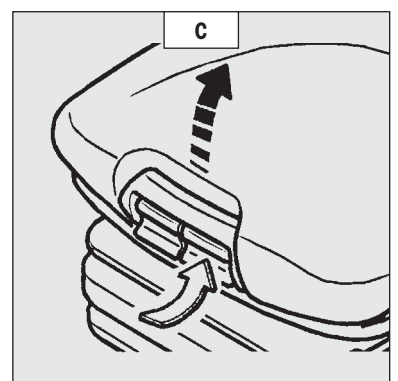
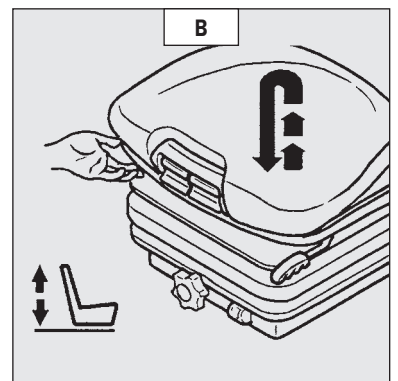

SEAT DEPTH ADJUSTMENT (FIG. D)

The depth of the seat may be adjusted to suit the individual.

- Press the right-hand button while raising or lowering the seat to find the desired position.

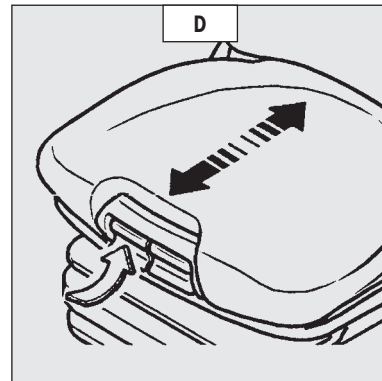

EXTENDING THE HEAD-REST (FIG. E)

- The height of the back-rest can be adjusted by pulling it upwards (the notches will click) up to the stop.
- The head-rest can be removed by applying sufficient pressure to pull it off the stop.

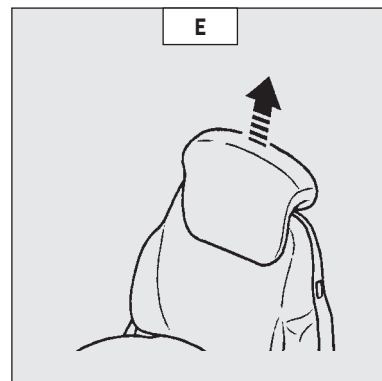

LUMBAR ADJUSTMENT (FIG. F)

This increases the comfort of the seat and the driver's freedom of movement.

- Turn the handle either left or right to adjust the height or depth of the lumbar support.

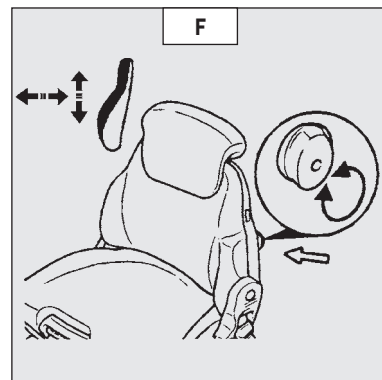

ADJUSTMENT OF THE ANGLE OF THE BACK-REST (FIG. G)

- Support the back-rest, pull the lever and position the back-rest to find the desired position.

⚠ If you do not support the back-rest when making adjustments, it swings completely forwards.

LONGITUDINAL ADJUSTMENT (FIG. H)

- Adjust the locking lever until you reach the position required. This then locks and the seat will not shift into another position.

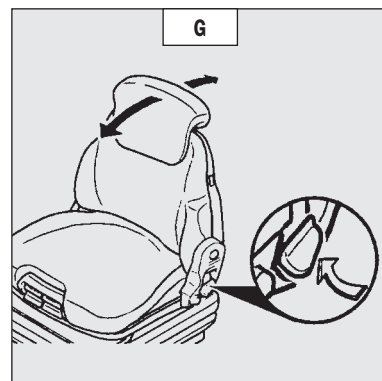

MAINTENANCE (FIG. I)

Dirt may adversely affect the correct functioning of the seat. For this reason, make sure your seat is always clean.

- To clean or change the cushions, simply remove them from the seat frame.

⚠ A rocking head-rest increases the risk of an accident!

Avoid wetting the cushion fabric when cleaning. Check the resistance of the fabric on a small hidden area before using any fabric or plastic cleaner.

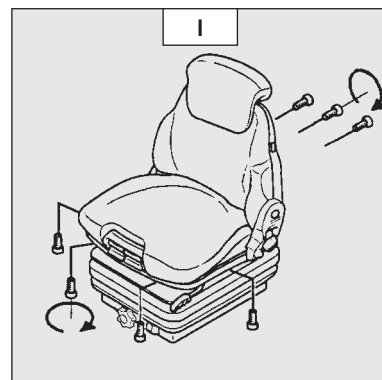
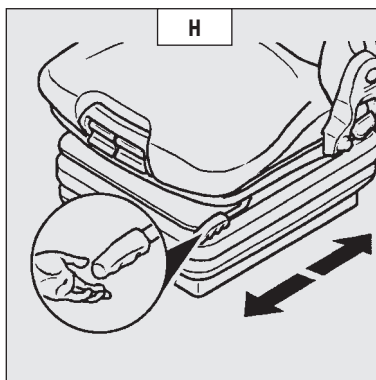

1 - PNEUMATIC DRIVER'S SEAT (OPTION)

DESIGNED FOR MAXIMUM COMFORT, THIS SEAT CAN BE ADJUSTED AS FOLLOWS.

WEIGHT ADJUSTMENT (FIG. A)

It is advised that you adjust the seat according to your weight when sitting.

- Switch on lift truck ignition.
- Push or pull lever 1 until green appears in display 2 indicating correct adjustment according to your weight.

NOTE: To avoid any health problems, it is recommended that the weight should be checked and adjusted before starting up the lift truck.

SEAT HEIGHT ADJUSTMENT (FIG. B)

When weight adjustment has been carried out, you can then modify seat height.

- Keep the ignition switched on.
- Push or pull lever 1 until green appears and adjust the height of the seat while checking that the green in display 2 remains visible.

! To avoid causing any damage, do not activate the compressor for over 1 minute.

SEAT BACK-REST ANGLE ADJUSTMENT (FIG. C)

The back-rest angle of the seat may be adjusted to suit the individual.

- Press the left-hand button while pushing on the seat or relaxing pressure on the seat to find a comfortable position.

SEAT DEPTH ADJUSTMENT (FIG. D)

The depth of the seat may be adjusted to suit the individual.

- Press the right-hand button while raising or lowering the seat to find the desired position.

EXTENDING THE HEAD-REST (FIG. E)

- The height of the back-rest can be adjusted by pulling it upwards (the notches will click) up to the stop.
- The head-rest can be removed by applying sufficient pressure to pull it off the stop.

LUMBAR ADJUSTMENT (FIG. F)

This increases the comfort of the seat and the driver's freedom of movement.

- Turn the handle either left or right to adjust the height or depth of the lumbar support.

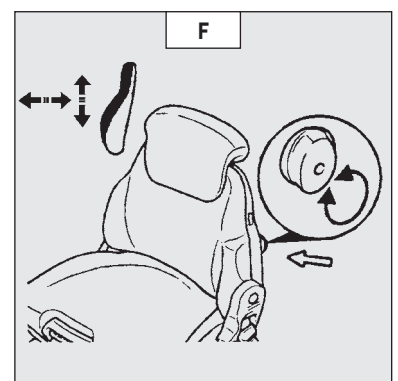
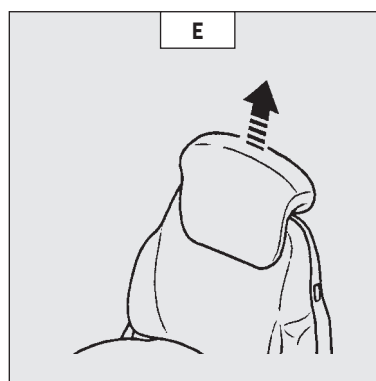
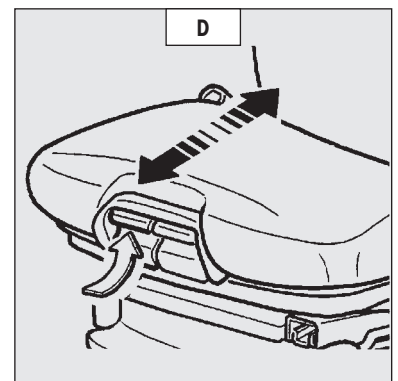
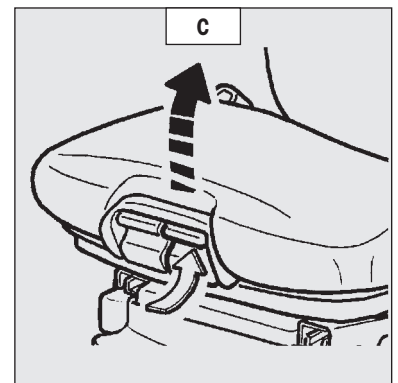
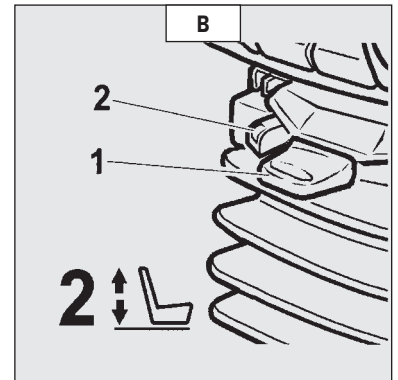
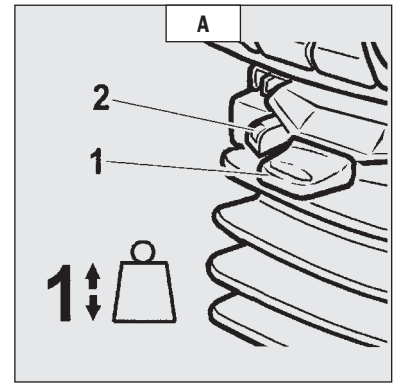

ADJUSTMENT OF THE ANGLE OF THE BACK-REST (FIG. G)

- Support the back-rest, pull the lever and position the back-rest to find the desired position.



If you do not support the back-rest when making adjustments, it swings completely forwards.

HORIZONTAL SHOCK ABSORBER (FIG. H)

In certain conditions (e.g. driving with a trailer) it is advised that a horizontal shock absorber be used. The driver's seat is thus better able to absorb jerks in the direction of travel.

- Position 1: Horizontal shock absorber fitted.
- Position 2: Horizontal shock absorber removed.

LONGITUDINAL ADJUSTMENT (FIG. I)

- Adjust the locking lever until you reach the position required. This then locks and the seat will not shift into another position.

MAINTENANCE (FIG. J)

Dirt may adversely affect the correct functioning of the seat. For this reason, make sure your seat is always clean.

- To clean or change the cushions, simply remove them from the seat frame.



A rocking head-rest increases the risk of an accident!

Avoid wetting the cushion fabric when cleaning. Check the resistance of the fabric on a small hidden area before using any fabric or plastic cleaner.

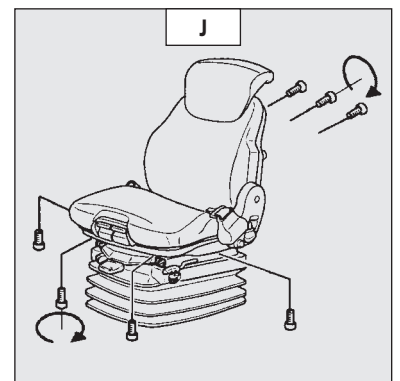
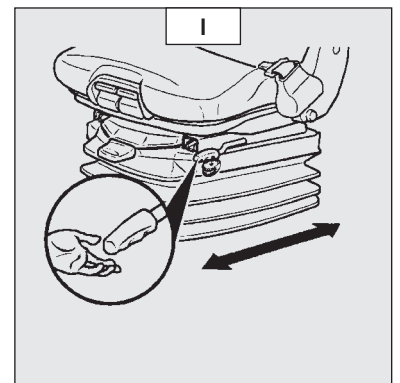
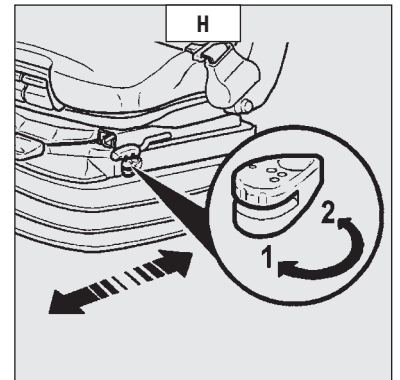
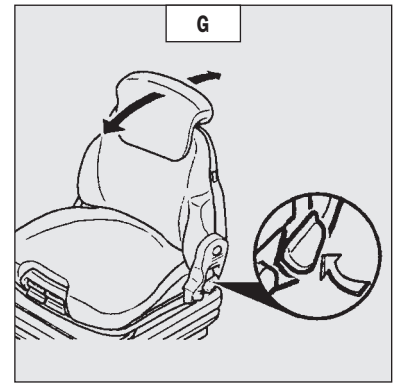

1 - PNEUMATIC LUXURY DRIVER'S SEAT (OPTION)

FOR MAXIMUM COMFORT, THIS SEAT CAN BE ADJUSTED AS FOLLOWS.

WEIGHT ADJUSTMENT (FIG. A)

It is advisable to adjust the seat according to your weight while sitting.

- Switch on the lift truck ignition.
- Pull or push lever 1 briefly. Adjustment is automatic.

NOTE: To avoid any health problems, it is recommended that the weight should be checked and adjusted before starting the lift truck.

SEAT HEIGHT ADJUSTMENT (FIG. B)

When weight adjustment has been carried out, you can then alter the seat height.

- Keep the ignition switched on.
- Push or pull lever 1 to adjust the height of the seat.

 **To avoid causing any damage, do not operate the compressor for over 1 minute.**

SEAT BACK-REST ANGLE ADJUSTMENT (FIG. C)

The back-rest angle of the seat may be adjusted to suit the individual.

- Press the left-hand button while pushing on the seat or relaxing pressure on the seat to find a comfortable position.

SEAT DEPTH ADJUSTMENT (FIG. D)

The depth of the seat may be adjusted to suit the individual.

- Press the right-hand button while raising or lowering the seat to find the desired position.

EXTENDING THE HEAD-REST (FIG. E)

- The height of the back-rest can be adjusted by pulling it upwards (the notches will be heard clicking) up to the stop.
- The head-rest can be removed by applying sufficient pressure to pull it off the stop.

LUMBAR ADJUSTMENT (FIG. F)

This increases the comfort of the seat and the driver's freedom of movement.

- Press the raise and lower switches to adjust the curvature of the seat back to your requirements.

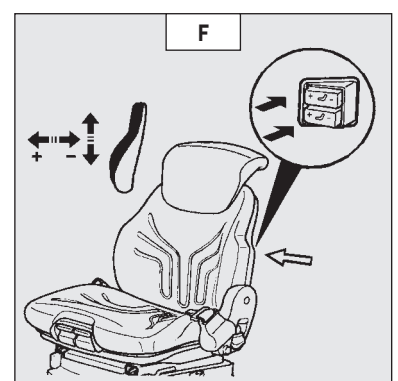
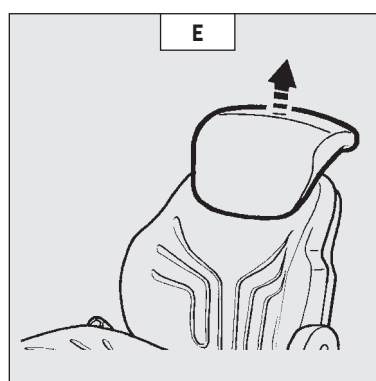
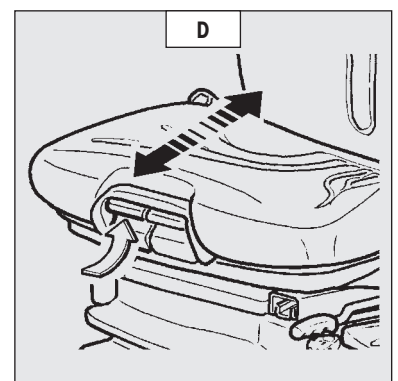
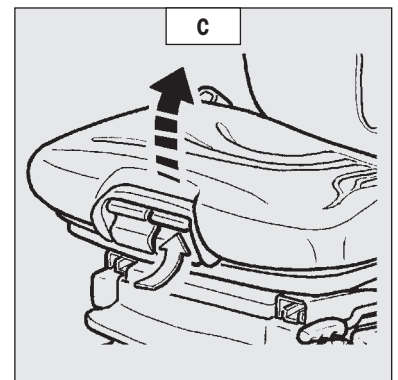
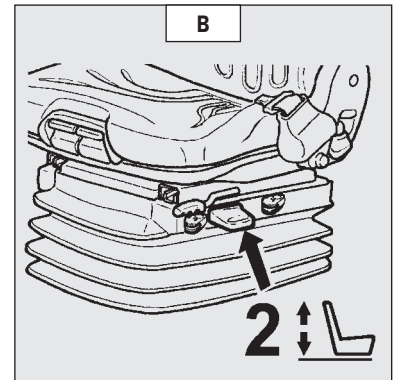
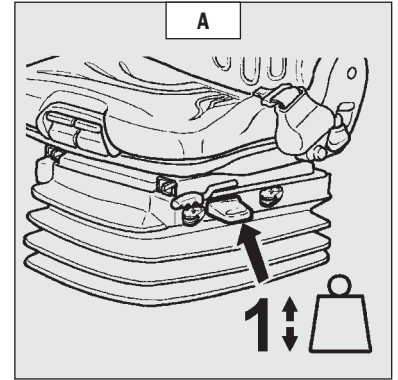

ADJUSTMENT OF THE ANGLE OF THE BACK-REST (FIG. G)

- Support the back-rest, pull the lever and tilt the back-rest to the desired position.

! *If you do not support the back-rest when making adjustments, it will swing fully forward.*

HORIZONTAL SHOCK ABSORBER (FIG. H)

In certain conditions (e.g. Driving with a trailer) it is advisable to use a horizontal shock absorber. The driver's seat is thus better able to absorb shocks in the direction of travel.

- Position 1: Horizontal shock absorber fitted.
- Position 2: Horizontal shock absorber removed.

DAMPING (FIG. I)

The damping of the seat can be adjusted to suit the nature of the terrain. The comfort of the seat is thus adjustable to suit your requirements.

- Position 1: Soft damping.
- Position 2: Hard damping.

LONGITUDINAL ADJUSTMENT (FIG. J)

- Engage the locking lever in the position shift into another position required. This then locks and the seat can not be moved to another position.

MAINTENANCE (FIG. K)

Dirt may adversely affect the correct functioning of the seat. For this reason, make sure your seat is always clean.

- To clean or replace the cushions, simply remove them from the seat frame.

! *A rocking back-rest increases the risk of an accident!*

Avoid wetting the cushion fabric when cleaning. Check the resistance of the fabric on a small hidden area before using any fabric or plastic cleaner.

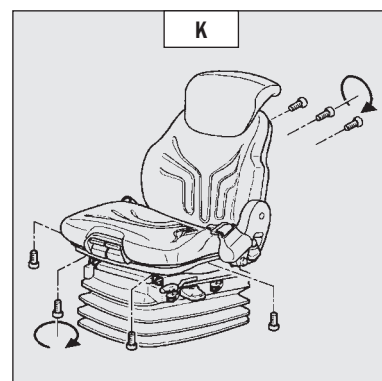
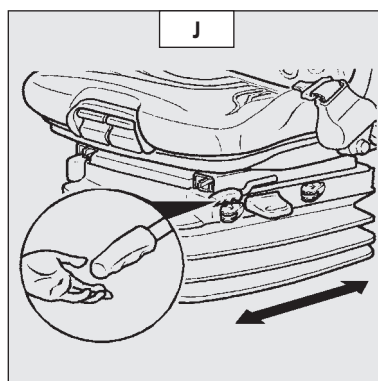
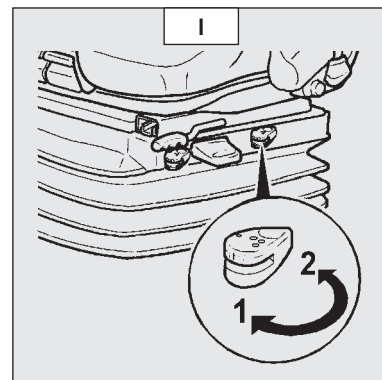
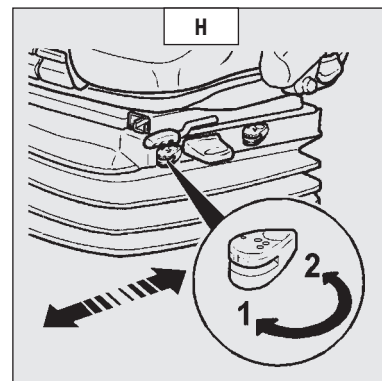
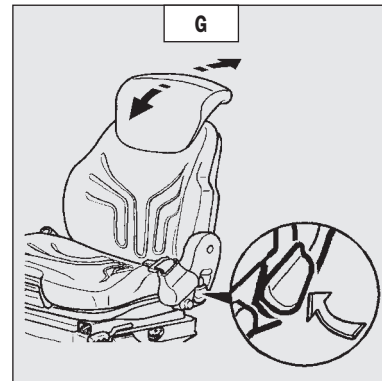

2 - SAFETY BELT

- Sit correctly on the seat.
- Check that seat belt is not twisted.
- Place the seat belt at hip level.
- Attach the seat belt and check that it locks.
- Adjust the seat belt to your body shape without squeezing your hip and without excessive play.

! *Under no circumstances should the lift truck be used if the seat belt is defective (fixing, locking, cuts, tears, etc.). Repair or replace the seat belt immediately.*

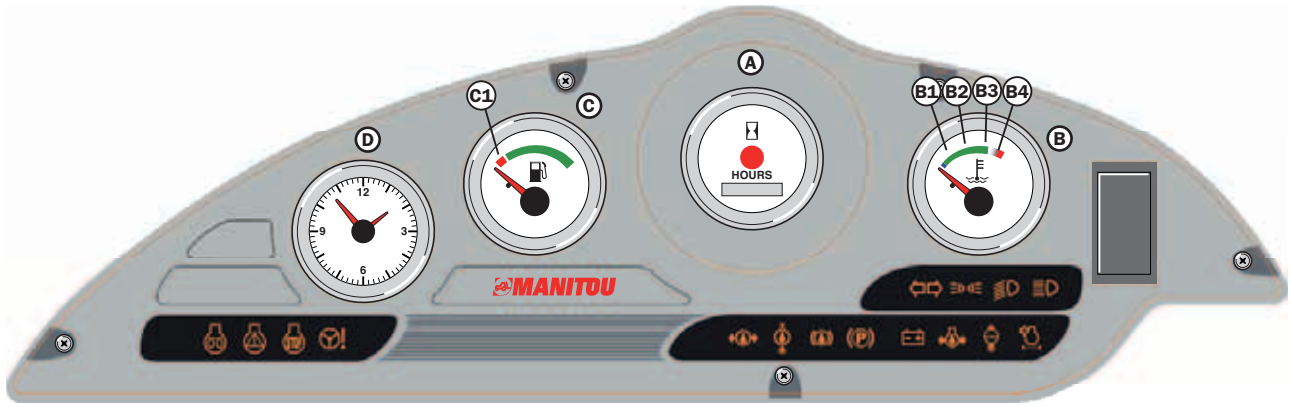

A - HOURMETER

B - I.C. ENGINE WATER TEMPERATURE

Temperature zone B1 - Blue zone (0° - 50°)

B2 - Green zone (50° - 100°)

B3 - Black/red zone (100° - 105°)

B4 - Red zone (105° - 120°)

NOTE: Red indicator light "J" comes on between zone B3 and B4.

C - FUEL LEVEL

Red zone C1 indicates that you are using the reserve supply and that time of use is limited.

D - TIME DIAL

SIGNAL LIGHTS

When activating the electrical system of the lift truck, all the red lamps and the panel's buzzer must light to indicate their good working order. If one of the red lamps or the buzzer does not function, carry out the necessary repairs.



RED TRANSMISSION OIL PRESSURE LAMP

The lamp and the buzzer come on when the pressure in the transmission, when driving forward, is abnormally low. Stop the lift truck and look for the cause (insufficient transmission oil level, internal leak in the transmission, etc.).

NOTE: The signal light operates in forward travel conditions only, the signal should be ignored when the lift truck has stopped or is idling.



RED TRANSMISSION OIL TEMPERATURE LAMP

The lamp and the buzzer come on when the converter oil temperature is abnormally high. Stop the lift truck and look for the cause of this overheating.



RED BRAKING OIL LEVEL LAMP

If the lamp and the buzzer come on, when the lift truck is running, stop the I.C. engine immediately and check the braking oil level. In the event of an abnormal dropping of the level, consult your dealer.



RED PARKING BRAKE LAMP

This lamp comes on when the parking brake is applied.



RED ALTERNATOR CHARGE LAMP

If the lamps E - F - H - I - J - K and the buzzer come on, when the lift truck is running, stop the I.C. engine immediately and check the electrical circuit as well as the alternator belt.



RED I.C. ENGINE OIL PRESSURE LAMP

If the lamp and the buzzer come on when the lift truck is running, stop the I.C. engine immediately and look for the cause (see oil level in I.C. engine crankcase).



RED I.C. ENGINE WATER TEMPERATURE LAMP

If the lamp and the buzzer come on when the lift truck is running, stop the I.C. engine immediately and investigate the cooling circuit for the cause of the malfunction.



RED LAMP - AIR FILTER OR HYDRAULIC RETURN FILTER CLOGGED

The lamp and buzzer come on when the air filter cartridge or the hydraulic return oil filter cartridge is clogged up. Stop the lift truck and carry out the necessary repairs (see cleaning and replacement requirements in chapter: 3 - MAINTENANCE: FILTERS CARTRIDGES AND BELTS).



GREEN DIRECTION INDICATOR LAMP



GREEN SIDELIGHTS LAMP



GREEN LOW BEAM LAMP



BLUE MAIN BEAM LAMP



OPTION



OPTION



OPTION



OPTION

4 - LONGITUDINAL STABILITY ALARM

This device warns the operator that the lift truck is approaching the limit of longitudinal stability. However, lateral stability can reduce the load chart in the upper part, and this reduction is not detected by the longitudinal stability alarm.

⚠ The operator must always respect the lift truck load chart.

OPERATION

When the lift truck is switched on a control test is automatically carried out.

- Correct operation: All leds and the sound alarm function continuously for 2 seconds.
- Faulty operation: All leds and sound alarm function intermittently (stop the lift truck and consult your dealer, never attempt a repair yourself).

A - LEDS (VISUAL ALARM) (FIG. A)

- A1 - 4 green leds: There is a large reserve of longitudinal stability.
- A2 - 2 yellow leds: The lift truck is approaching the limit of longitudinal stability, move carefully.
- A3 - 1 red led: The lift truck is very near at the limit of longitudinal stability. The alarm sounds simultaneously with a slow intermittent sound. Move very carefully.
- A4 - 1 red led: The lift truck is at the authorized limit of longitudinal stability. The alarm sounds simultaneously with a speed intermittent sound. Only make de-aggravating hydraulic movements in the following order ; retract and raise the jib.

B - SOUND ALARM SWITCH (FIG. A)

Used to switch off the sound alarm when using the lift truck with loading and earth moving buckets. When it is switched off, the red led B1 indicates that the sound alarm has been cut off and only the visual alarm is working. Under other operating conditions, the sound alarm must be switched on.

C - TEST SWITCH (FIG. A)

Press the switch to verify at any time that the longitudinal stability alarm is working.

NOTE: This test does not verify that the alarm is correctly set ; this must be checked at every periodic service.

- Correct operation: All leds and the sound alarm function continuously.
- Faulty operation: All leds and the sound alarm function intermittently (stop the lift truck and consult your dealer, never attempt a repair yourself).

D - STRAIN GAUGE (FIG. B)

⚠ Disassembly or adjustment of the strain gauge is prohibited, this must only be done by specially trained personnel, consult your dealer.

MT 728 Série C-E2

MT 928 Série C-E2

NOTE: The cutting-off of "SIMPLE" hydraulic movements is installed in series (See: 2 - DESCRIPTION: DESCRIPTION AND USE OPTIONS).

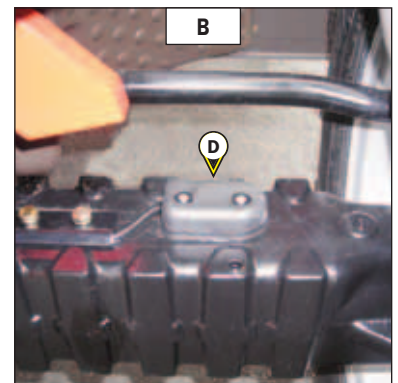
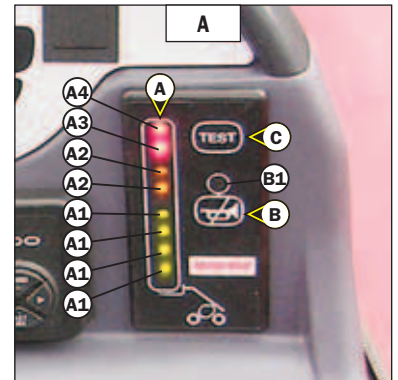

5 - SWITCH PANEL

NOTE: The location of the switches may vary depending on the options.

A - OPTION

MT 732 Série C-E2

MT 732 Turbo Série C-E2

MT 932 Série C-E2

MT 932 Turbo Série C-E2

MT 1030 S Série 3-E2

MT 1030 S Turbo Série 3-E2

- OPTION Electrical jib provision (See: 2 - DESCRIPTION: DESCRIPTION AND USE OPTIONS).

B - OPTION

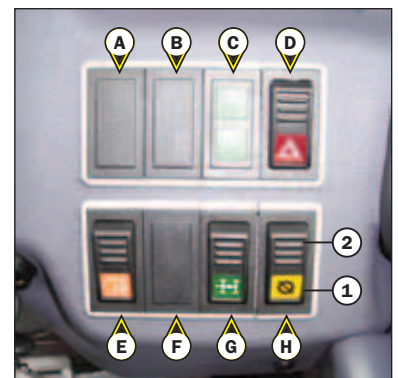

C - WHEEL ALIGNMENT LAMPS

D - WARNING LIGHTS

E - REAR FOG LIGHT

F - OPTION

MT 732 Série C-E2

MT 732 Turbo Série C-E2

MT 932 Série C-E2

MT 932 Turbo Série C-E2

MT 1030 S Série 3-E2

MT 1030 S Turbo Série 3-E2

- OPTION Self-cleaning fan (See: 2 - DESCRIPTION: DESCRIPTION AND USE OPTIONS).

G - STEERING SELECTION

H - TRANSMISSION CUT-OFF

The switch selects transmission cut-off to the service brake pedal or the hydraulic controls lever.

Position 1: Indicator light on, transmission cut-off to service brake pedal effected.

Position 2: Indicator light off, transmission cut-off to hydraulic control lever effected.

NOTE: In all cases transmission cut-off can be effected using the gear lever.

USE OF TRANSMISSION CUT-OFF

Transmission cut-off to brake pedal (position 1).

- When loading.

Transmission cut-off to hydraulic controls lever (position 2).

- When driving.
- For inching and continuous stopping and starting (delicate handling). In order to optimise hydraulic movements, cut off transmission to the hydraulic controls lever.
- Starting up on a slope.

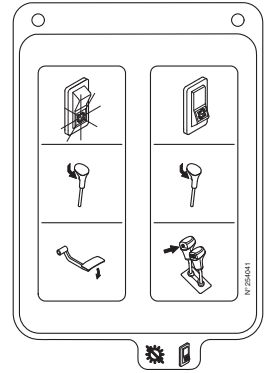

I - REVOLVING LIGHT

J - OPTION FRONT AND REAR WORKING LIGHTS

K - OPTION

MT 732 Série C-E2

MT 732 Turbo Série C-E2

MT 932 Série C-E2

MT 932 Turbo Série C-E2

MT 1030 S Série 3-E2

MT 1030 S Turbo Série 3-E2

- OPTION Jib head light

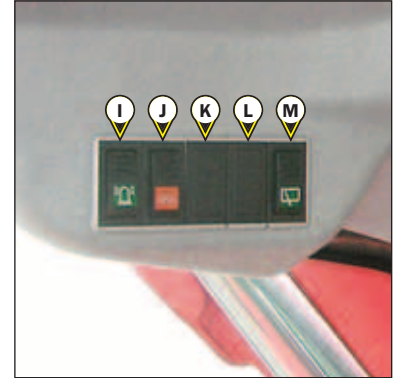

L - REAR WINDOW DEFROSTING OPTION

M - SIDE WINDSCREEN WIPER + ROOF WINDSCREEN WIPER OPTION

N - OPTION

O - OPTION

P - OPTION

MT 732 Série C-E2

MT 732 Turbo Série C-E2

MT 932 Série C-E2

MT 932 Turbo Série C-E2

MT 1030 S Série 3-E2

MT 1030 S Turbo Série 3-E2

- OPTION Attachment hydraulic locking device (See: 2 - DESCRIPTION: DESCRIPTION AND USE OPTIONS).



Q - OPTION

6 - LIGHT SWITCH, HORN AND INDICATOR SWITCH

The switch controls the visual and sound alarms.

- A - All lights are off, the direction indicators do not flash.
- B - The right hand direction indicators flash.
- C - The left hand direction indicators flash.
- D - The sidelights and the rear lights are on.
- E - The dipped headlights and the rear lights are on.
- F - The main beam headlights and the rear lights are on.
- G - Headlight signal.

Pressing the switch sounds the horn.

NOTE: The positions D - E - F - G can be carried out without the ignition being on.

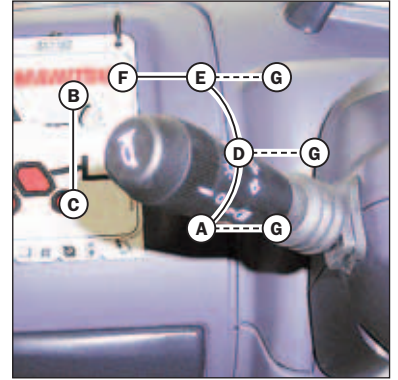

7 - FRONT AND REAR WINDSCREEN WIPER SWITCH

This switch controls the operation of the front and rear windscreen wipers.

- A - Front windscreen wiper off.
- B - Front windscreen wiper low speed setting.
- C - Front windscreen wiper high speed setting.
- D - Front windscreen wiper intermittent setting.
- E - Rear windscreen wiper off.
- F - Rear windscreen wiper on.

NOTE: These functions will only work when the ignition is switched on.

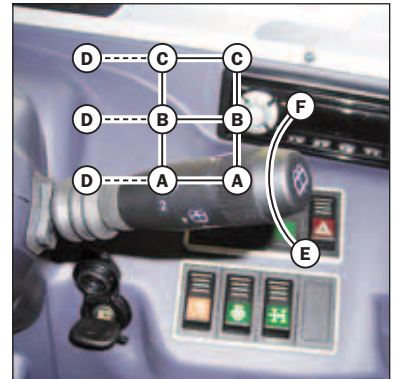

8 - IGNITION SWITCH

The key switch has five positions:

- P - Ignition off, parking position.
- O - Ignition switched off and I.C. engine stopped.
- I - Ignition on.
- II - Heating.
- III - The I.C. engine starts, return to position i as soon as the key is released.

9 - BRAKING OIL TANK AND WINDSCREEN WASHER ACCESS PANEL

- Loosen screw 1 and lift up the brake fluid and windscreen washer access panel.



10 - BRAKING OIL TANK

See: 3 - MAINTENANCE: B - EVERY 50 HOURS SERVICE.

11 - WINDSCREEN WASHER TANK

See: 3 - MAINTENANCE: B - EVERY 50 HOURS SERVICE.

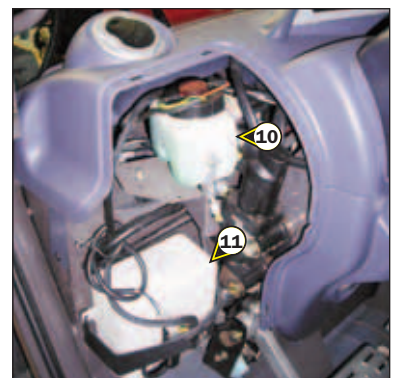

12 - FUSE AND RELAY ACCESS PANEL

- Lift up the fuse and relay access panel 12.



13 - FUSE AND RELAY

A sticker on the inside of the access panel gives a clear display of the use of the components described below.

- K0 - OPTION Air conditioning.
- K1 - OPTION.
- K2 - Transmission cut-off relay.
- K3 - Reverse gear relay.
- K4 - Forward gear relay..
- K5 - Buzzer.
- K6 - OPTION Electrovalve on jib head. (B C E F G H)
 - OPTION Electrical jib provision. (B C E F G H)
 - OPTION Electrovalve on jib head + Attachment hydraulic locking device. (B C E F G H)
 - OPTION. (A D)
- K7 - Cutting off "simple" hydraulic movements. (A D)
 - OPTION Cutting off "simple" hydraulic movements. (B C E F G H)
 - OPTION Cutting off "aggravating" hydraulic movements.
- K8 - Safety system starting switch relay
- K9 - Flashing unit.
- K14 - OPTION Diesel decongealant. (B C E F G H)
- K16 - Preheating I.C. engine relay.

- A: MT 728 Série C-E2
- B: MT 732 Série C-E2
- C: MT 732 Turbo Série C-E2
- D: MT 928 Série C-E2
- E: MT 932 Série C-E2
- F: MT 932 Turbo Série C-E2
- G: MT 1030 S Série 3-E2
- H: MT 1030 S Turbo Série 3-E2

NOTE: Replace a used fuse with a new fuse of the same quality and capacity.
Never reuse a repaired fuse.

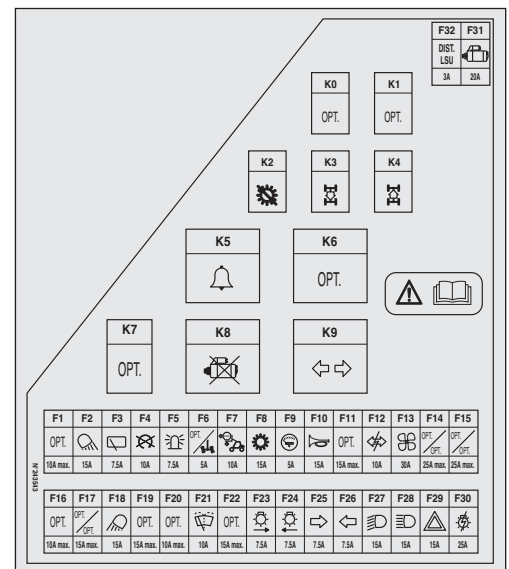

- F1 - (10A MAXI) - Safety stabilisers (7,5A). (G H)
 - OPTION. (A B C D E F)
- F2 - (15A MAXI) - OPTION Working tail light (10A).
- F3 - (10A MAXI) - Rear windscreen wiper (7,5A).
 - OPTION Roof windscreen wiper (7,5A).
 - OPTION Side windshield wiper (7,5A).
- F4 - (10A MAXI) - Stop I.C. engine electrovalve (7,5A).
 - OPTION.
- F5 - (10A MAXI) - Flashing light (7,5A).
- F6 - (7,5A MAXI) - Alignment of the wheels (5A).
- F7 - (15A MAXI) - Longitudinal stability alarm (10A).
 - Cutting off "simple" hydraulic movements (10A). (A D)
 - OPTION Cutting off "simple" hydraulic movements (10A). (B C E F G H)
 - OPTION Cutting off "aggravating" hydraulic movements (10A).
- F8 - (15A MAXI) - Reversing gear (15A).
 - Transmission cut-off (15A).
 - Reverse buzzer alarm (15A).
 - Reverse lights (15A).
- F9 - (10A MAXI) - Control instruments panel (5A).
- F10 - (15A MAXI) - Sound alarm (15A).
 - Stop switch (15A).
- F11 - (15A MAXI) - OPTION Jib head light (10A). (B C E F G H)
 - OPTION Blue front and rear working lights (10A). (B C E F)
 - OPTION. (A D)
- F12 - (10A MAXI) - Indicator power supply (10A).
- F13 - (35A MAXI) - Heating (30A).
- F14 - (25A MAXI) - OPTION.
- F15 - (25A MAXI) - OPTION.
- F16 - (10A MAXI) - OPTION Air conditioning (7,5A).

- F17 - (15A MAXI) - OPTION Electrovalve on jib head (10A). (B C E F G H)
- OPTION Electrovalve on jib head + attachment hydraulic locking device (10A). (B C E F G H)
- OPTION Electrical jib provision (10A). (B C E F G H)
- OPTION Anti-theft device provision (10A).
- OPTION Anti-theft system (10A).
- OPTION Système antidémarrage (10A).
- OPTION Anti-start system (10A). (B C E F G H)
- OPTION Self-cleaning fan (10A). (B C E F G H)
- OPTION Electrovalve on jib head + self-cleaning fan(15A). (B C E F G H)
- F18 - (15A MAXI) - OPTION Front working head light (15A).
- F19 - (15A MAXI) - OPTION Rear window defrosting (15A).
- F20 - (10A MAXI) - OPTION Pneumatic seat (10A).
- F21 - (10A MAXI) - Essuie-glace avant et lave glace (10A).
- F22 - (15A MAXI) - OPTION.
- F23 - (10A MAXI) - Right sidelight (7,5A).
- Sidelight indicator light (7,5A).
- Control panel lighting (7,5A).
- OPTION Number plate lighting (7,5A). (B C E F G H)
- F24 - (10A MAXI) - Left sidelights (7,5A).
- F25 - (10A MAXI) - Right indicators (7,5A).
- F26 - (10A MAXI) - Left indicators (7,5A).
- F27 - (15A MAXI) - Low beam (15A).
- Low beam indicator light (15A).
- Rear fog light (15A).
- F28 - (15A MAXI) - Main beam (15A).
- Main beam lamp (15A).
- F29 - (25A MAXI) - Hazard warning lights power supply (15A).
- Roof light (15A).
- OPTION (+)permanent (15A).
- F30 - (25A MAXI) - Light switch power supply, horn and indicators (25A).
- F31 - (20A MAXI) - Starter (20A).

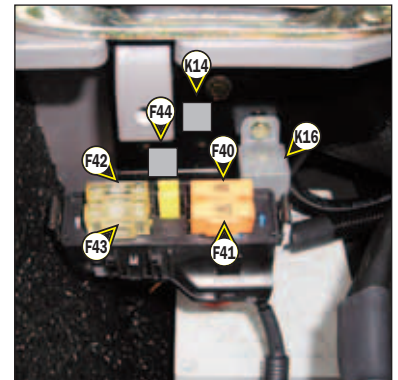
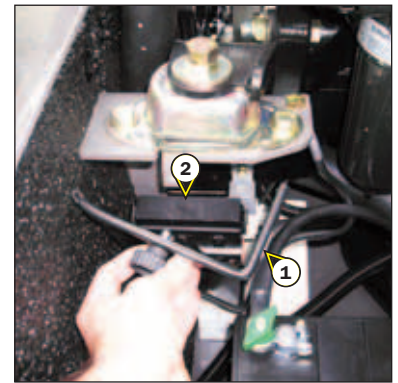

Remove casing 1 and cover 2 for access to fuses F40 to F44 and to relay K16.

- F40 - (40A MAXI) - Lift truck electrical equipment (40A).
- F41 - (40A MAXI) - Lift truck electrical equipment (40A).
- F42 - (80A MAXI) - Preheating I.C. engine (80A).
- F43 - (80A MAXI) - Alternator (80A).
- F44 - (15A MAXI) - OPTION Diesel decongealant (15A). (B C E F G H)

14 - ACCELERATOR PEDAL

- MT 732 Série C-E2
- MT 732 Turbo Série C-E2
- MT 932 Série C-E2
- MT 932 Turbo Série C-E2
- MT 1030 S Série 3-E2
- MT 1030 S Turbo Série 3-E2

NOTE: There is an OPTIONAL hand-operated accelerator in the cabin.

15 - SERVICE BRAKE PEDAL AND TRANSMISSION CUT-OFF

- MT 728 Série C-E2
- MT 928 Série C-E2

The pedal applies on the front wheels by an hydraulic brake system, and allows the lift truck to be slowed down and stopped. Depending on the position of the transmission cut-off switch, it enables the free travel to cut off transmission (see: 2 - DESCRIPTION: 5 - SWITCHES PANEL).

- MT 732 Série C-E2
- MT 732 Turbo Série C-E2
- MT 932 Série C-E2
- MT 932 Turbo Série C-E2
- MT 1030 S Série 3-E2
- MT 1030 S Turbo Série 3-E2

The pedal applies on the front and rear wheels by an hydraulic brake system, and allows the lift truck to be slowed down and stopped. Depending on the position of the transmission cut-off switch, it enables the free travel to cut off transmission (see: 2 - DESCRIPTION: 5 - SWITCHES PANEL).

16 - GEAR LEVER AND TRANSMISSION CUT-OFF

In order to change speeds, it is necessary to cut the transmission by pressing the button 1 on the lever.

- 1st gear: To the right, backwards.
- 2nd gear: To the right, forwards.
- 3rd gear: To the left, backwards.
- 4th gear: To the left, forwards.

USING THE GEARS ON THE GEAR BOX

- On these lift trucks with a torque converter, it is not necessary to automatically start up in 1st speed and progress up the gears.

⚠ The choice of gear ratio should be made carefully according to the nature of the work being carried out. A poor choice may result in the extremely rapid elevation of the transmission oil temperature through excessive slipping of the converter, which could lead to serious damage to the transmission (it is essential to stop and change the working conditions if the transmission oil temperature indicator light comes on). This poor choice may also result in a reduction in the lift truck's performance in forward speed. When the forward force increases, the forward speed in the g gear (for example 3rd gear) may be lower than the forward speed that could be obtained with the g-1 gear (in 2nd instead of the 3rd).

In general, we would advise you to use the following gears according to the nature of the work being carried out.

- On the road: Set off in 3rd gear and go up to 4th if the conditions and state of the road permit it. In hilly areas, set off in 2nd gear and go up to 3rd if the conditions and state of the road permit it.
- With a trailer on the road: Set off in 2nd gear and go up to 3rd if the conditions and state of the road permit it.
- Handling: 3rd gear.
 - 2nd gear in restricted spaces.
- Loading (reclaiming with bucket, manure fork, etc.): 2nd gear.
- Earth moving: 1st gear.

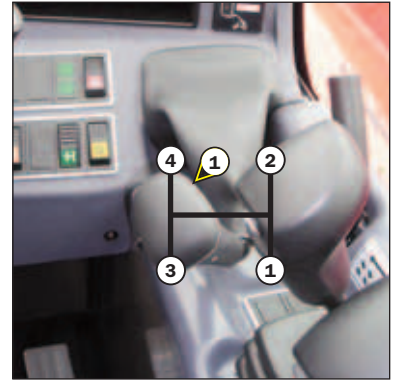

17 - REVERSING GEAR

FORWARD: Push the knob forward (position A).

REVERSE: Pull the knob backwards (position B).

NEUTRAL: The knob must be in the intermediate position to start the lift truck (position C).

When operating this control, the lift truck should be travelling at slow speed and not accelerating.

NOTE: The reverse lights indicate that the lift truck is running in reverse motion. An OPTIONAL audible reversing alarm can also be fitted.

SAFETY FOR MOVING THE LIFT TRUCK

Authorization to move the lift truck is controlled by an electronic unit. The operator must observe the following sequence to move the truck forwards or backwards:

- 1 - sit down correctly in the driver's seat,
- 2 - release the parking brake,
- 3 - engage forward or reverse movement.

To stop the lift truck, he must observe the following sequence:

- 1 - set the reversing gear in neutral,
- 2 - engage the parking brake,
- 3 - get out of the lift truck.

NOTE: If the operator leaves the driver's cab with forward or reverse movement, an acoustic alarm sounds continuous, the operator can sit down again and to continue forward or reverse displacement.

If the acoustic alarm sounds discontinuous, the operator must sit down, set the reversing gear in neutral and engage forward or reverse movement if he wants to continue the displacement.



18 - PARKING BRAKE LEVER

To prevent accidental loosening or release, the lever is fitted with safety locking.

- To apply the parking brake, pull the lever backwards (position A).
- To loosen the parking brake, release and push the lever forwards (position B).

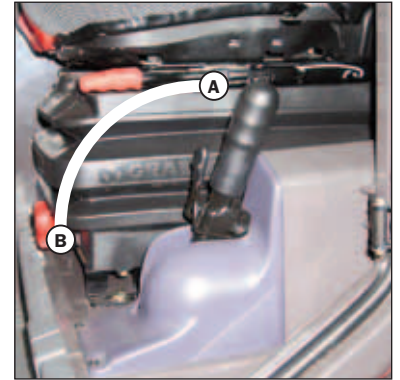

19 - STEERING SELECTOR

Before selecting one of the three possible steering positions, bring the 4 wheels into alignment, i.e., in the straight ahead position.

A - STEERING SELECTION LEVER

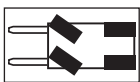

A1 - Front wheel steer (highway traffic).

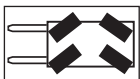

A2 - Front and rear wheels steer in opposite direction (4 wheel steer).

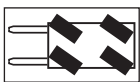

A3 - Front and rear wheels steer in the same direction (crab steer).

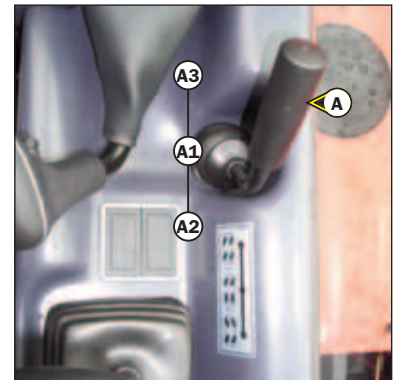

B - GREEN LAMPS FOR ALIGNMENT OF THE WHEELS

These lamps come on to indicate the alignment of the wheels, in relation to the axle of the lift truck. The lamp B1 for the front wheels and the lamp B2 for the rear wheels.

C - SWITCH FOR ALIGNMENT OF THE WHEELS

This switch enables the use or not of the device for alignment of the wheels. The indicator light indicates its use.

WHEEL ALIGNMENT PROCEDURE

- Connect the switch (signal light ON).
- Shift the distributor control lever for steering selection A in position A2 (4 wheel steering).
- Turn the steering wheel and bring the rear wheels into alignment until the lamp B2 is on.
- Shift the distributor control lever for steering selection A in position A1 (highway traffic).
- Turn the steering wheel and bring the front wheels into alignment until the lamp B1 is on.

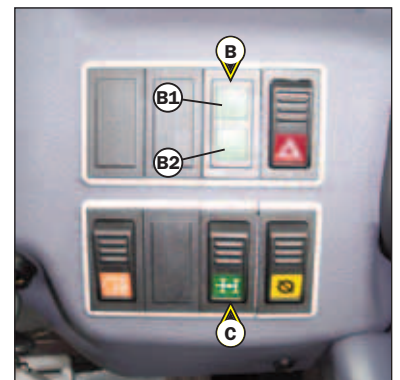

⚠ Before driving on roads, it is necessary to check the alignment of the rear wheels and to drive in front wheel steer. The control of the alignment of the rear wheels must be regularly done with the help of the green lamps, while driving the lift truck. In case of anomalies, consult your dealer.

20 - HYDRAULIC CONTROLS AND TRANSMISSION CUT-OFF

⚠ Do not attempt to alter the hydraulic system pressure. In the event of suspected malfunction, contact your dealer. ANY ALTERATION MAY RENDER THE WARRANTY NULL AND VOID.

⚠ Use the hydraulic controls carefully without jerking, to avoid accidents caused by shaking the lift truck.

MT 728 Série C-E2
MT 928 Série C-E2

LIFTING OF THE LOAD

- The lever A or B backwards when lifting.
- The lever A or B forwards when lowering.

TILT OF THE CARRIAGE

- The lever B to the left for reverse tilt.
- The lever B to the right for forward tilt.

TELESCOPING

- The lever A to the right for the extension.
- The lever A to the left for the retraction.

NOTE : Only for MT 928 Série C-E2

When completely retracting the telescopes, insistently operate the control so as to allow all the telescopes to retract fully.

TRANSMISSION CUT-OFF

- Button C (see: 2 - DESCRIPTION: 5 - SWITCHES PANEL).

REVERSING GEAR

- Switch D (see: 2 - DESCRIPTION: 17 - REVERSING GEAR).

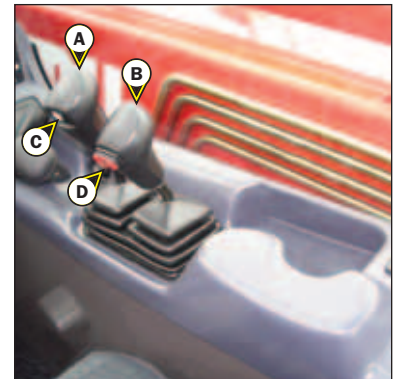
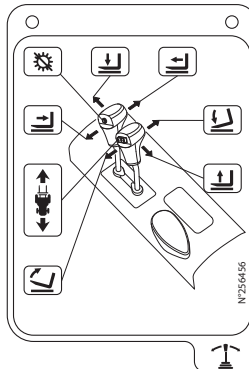

MT 732 Série C-E2
MT 732 Turbo Série C-E2
MT 932 Série C-E2
MT 932 Turbo Série C-E2

LIFTING THE LOAD

- Move lever A or B backwards to lift.
- Move lever A or B forwards to lower.

TILT OF CARRIAGE

- Move lever B to the left to excavate.
- Move lever B to the right to tip.

TELESCOPING

- Move lever A to the right to extend.
- Move lever A to the left to retract.

NOTE: Only for MT 932 Série C-E2

When completely retracting the telescopes, insistently operate the control so as to allow all the telescopes to retract fully.

ATTACHMENT

- Raise lever C and turn to the left or right.

TRANSMISSION CUT-OFF

- Switch D (see: 2 - DESCRIPTION: 5 - SWITCH PANEL).

REVERSING GEAR

- Switch E (see: 2 - DESCRIPTION: 17 - REVERSING GEAR).

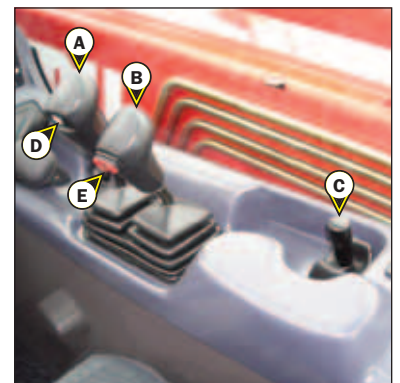
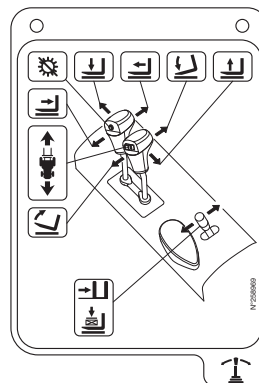

MT 1030 S Série 3-E2
 MT 1030 S Turbo Série 3-E2

LIFTING THE LOAD

- Move lever A or B backwards to lift.
- Move lever A or B forwards to lower.

TILTING THE CARRIAGE

- Move the lever B to the left to excavate.
- Move the lever B to the right to tip.

TELESCOPING

- Move lever A to the right to extend.
- Move lever A to the left to retract.

NOTE: When completely retracting the telescopes, keep operating the control until the telescopes are fully retracted.

LEFT STABILIZER

- Move lever C forwards to lowering.
- Move lever C backwards for lifting.

RIGHT STABILIZER

- Move lever D forwards for lowering.
- Move lever D backwards for lifting.

NOTE: The stabilizers can only be raised after the jib has been retracted.

ATTACHMENT

- Raise lever E and turn to the left or right.

TRANSMISSION CUT-OFF

- Button F (see: 2 - DESCRIPTION: 5 - SWITCH PANEL).

REVERSING GEAR

- Button G (see: 2 - DESCRIPTION: 17 - REVERSING GEAR).

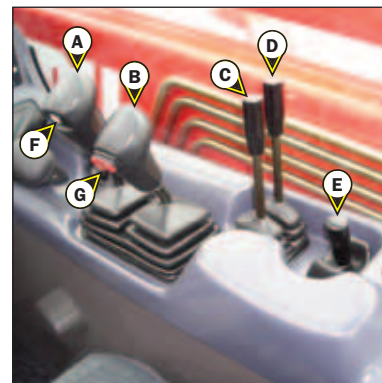
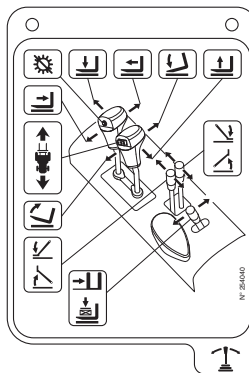

21 - LOAD CHART FILE

This file includes the description of the hydraulic controls and the load charts of the attachments used on the lift truck.

22 - HEATER CONTROL

A - HEATING FAN CONTROL

This 3-speed control regulates warm or cold air through the heating ventilators.

B - HEATING TEMPERATURE CONTROL

Allows the temperature inside the cab to be adjusted.

B1 - With the valve closed, the fan delivers fresh air.

B2 - With the valve opened completely, the fan delivers warm air.

The intermediate positions allow the temperature to be adjusted.



22 - AIR CONDITIONING CONTROLS (AIR CONDITIONING OPTION)

⚠ *The air conditioning only comes on when the forklift truck has been started up. When using your air conditioning, you must work with the doors and windows closed.*

In winter: So as to ensure correct operation and complete efficiency of the air conditioning unit, start up the compressor once a week, if only for a short spell, so as to lubricate the internal seals.

In cold weather: Warm the I.C. engine before switching on the compressor, so as to allow the coolant that has collected in the liquid state at the lowest point of the compressor circuit to turn into gas under the effect of the heat given off by the I.C. engine, as the compressor is liable to be damaged by coolant in the liquid state.

⚠ *If your air conditioning does not seem to be working properly, have it examined by your dealer (see: 3 - MAINTENANCE: H - EVERY 2 YEARS "AIR CONDITIONING OPTION"). Never try to repair any possible problems by yourself.*

DESCRIPTION OF THE AIR CONDITIONING CONTROLS

A - Air conditioning system ON/OFF control switch with indicator lamp. Only works when control switch "C" set to 1, 2 or 3.

B - Air temperature control.

C - Air flow and fan speed control. When this control is set to "0" the air conditioning system will not work.

NOTE: Possible losses of water under the lift truck are due to condensate discharges caused by the drying effect of the installation, especially with high outside temperatures and high relative humidity.

For the air conditioning to perform properly, the air intakes must not be blocked by frost, snow or leaves.

When the facility is running, at least one of the cab air grilles must be open so as to avoid any risk of freezing to the evaporator.

HEATING MODE

The controls must be adjusted in the following way:

A - Control with signal light off.

B - At the required temperature.

C - To the desired position 1, 2 or 3.

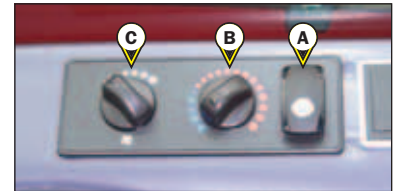

CONDITIONED AIR MODE

The controls must be adjusted in the following way:

A - Control with signal light on.

B - At the required temperature.

C - To the desired position 1, 2 or 3.

DEMISTING MODE

The controls must be adjusted in the following way:

A - Control with signal light on.

B - At the required temperature.

C - To the desired position 1, 2 or 3.

NOTE: Direct the ventilators onto the cab's windows for increased efficiency.

23 - CAB FILTER VENTILATORS

See: 3 - MAINTENANCE: D - EVERY 500 HOURS SERVICE.

24 - WINDSCREEN DEMIST VENTS

For optimum effectiveness, close the heating ventilators.

25 - HEATING VENTS

These heating vents enable the air to be directed to the interior of the cabin and onto the side windows.

26 - DOOR LOCK

Two keys are provided with the lift truck to enable the cabin to be locked.

27 - LOCKING HANDLE FOR UPPER HALF DOOR

28 - RELEASING BUTTON FOR UPPER HALF DOOR

29 - HANDLE FOR REAR WINDOW OPENING

EMERGENCY EXIT

Use the rear window as an emergency exit, if it is impossible to leave the cab by the door.



30 - TOOL BOX AND DOCUMENT HOLDER

Ensure that the operator's manual is in its place in the document holder.

NOTE: There is an OPTIONAL waterproof document holder.

31 - FRONT LIGHTS

- A - Left front indicator.
- B - Left front dipped headlight.
- C - Left front main beam.
- D - Left front sidelight.
- E - Right front indicator.
- F - Right front dipped headlight.
- G - Right front main beam.
- H - Right front sidelight.

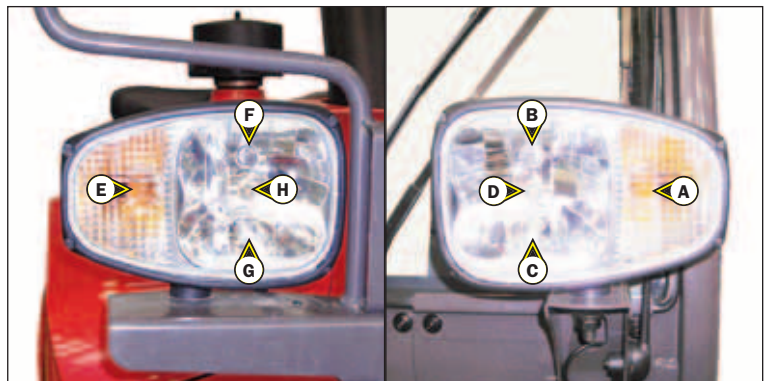

32 - REAR LIGHTS

- A - Left rear indicator.
- B - Left rear stoplight.
- C - Left tail light.
- D - Left rear reverse light.
- E - Left rear fog light.
- F - Right rear fog light.
- G - Right rear reverse light.
- H - Right tail light.
- I - Right rear stoplight.
- J - Right rear indicator.

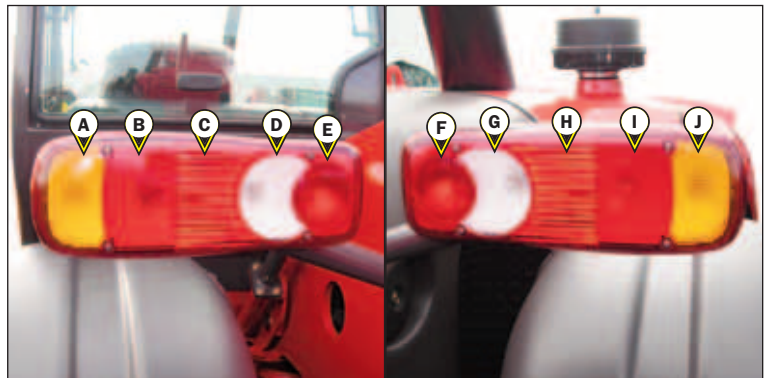

33 - REVOLVING LIGHT

The magnetic revolving light must be clearly visible on the roof of the cab and plugged-in to socket 1.

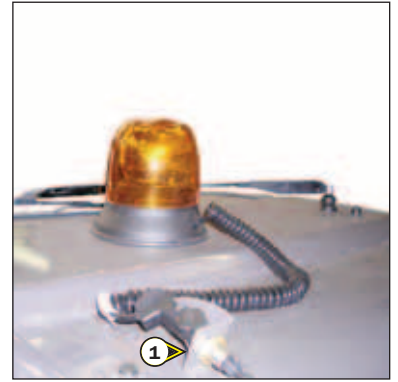

34 - DOCUMENT HOLDER NET

35 - SPIRIT LEVEL

Enables the operator to check that the lift truck is in the horizontal position.

36 - SUN VISOR (OPTION)

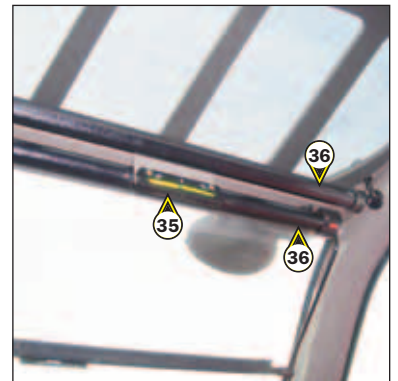

37 - ROOF LIGHT

38 - HOOK

